



76 mm

3M

114 mm

76 mm

3.5M

114 mm

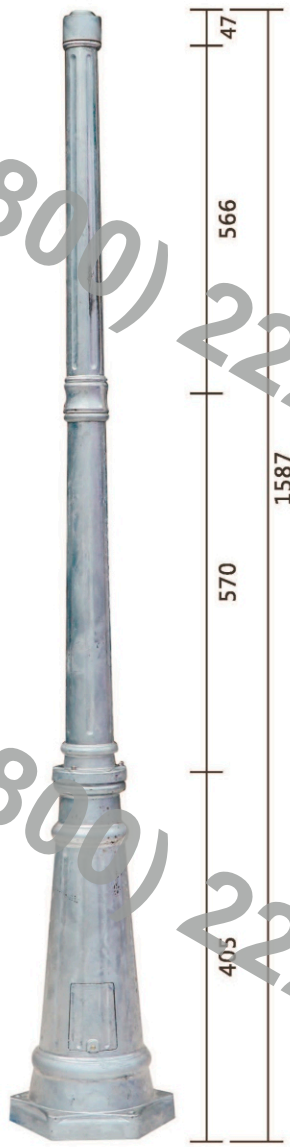
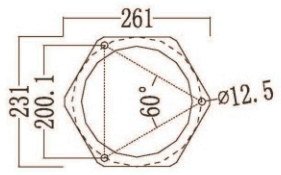

CR5001-1

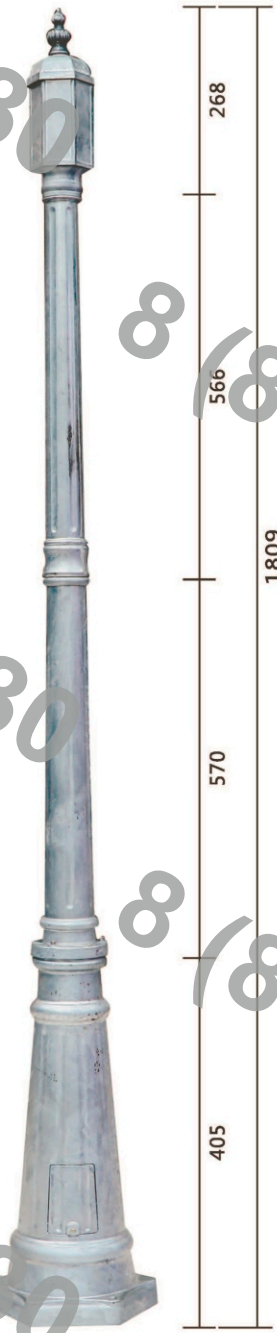

CR5001-2

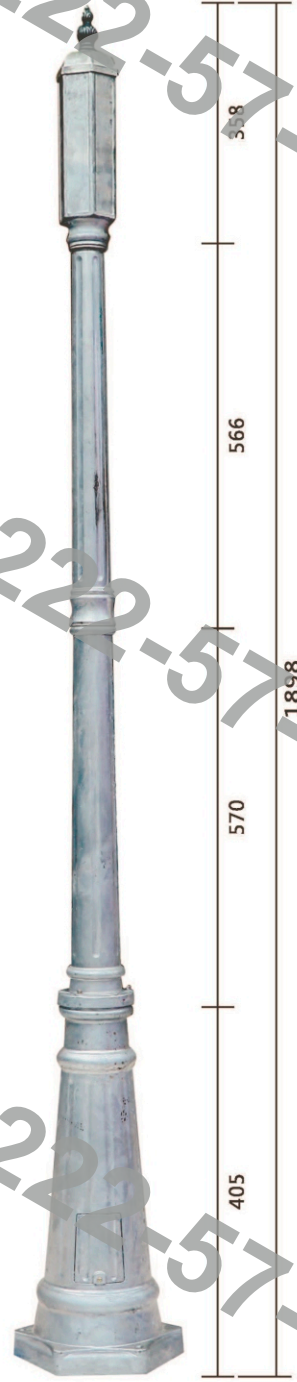

CR5001-3

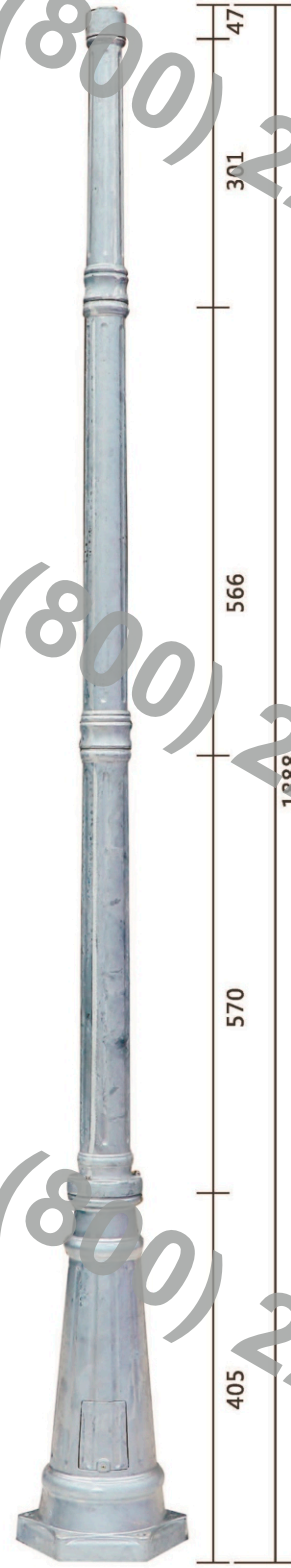

CR5002-1

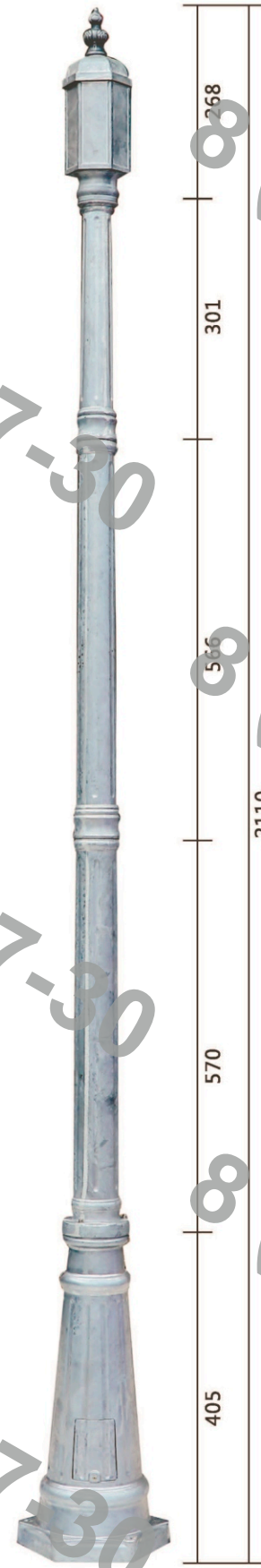

CR5002-2

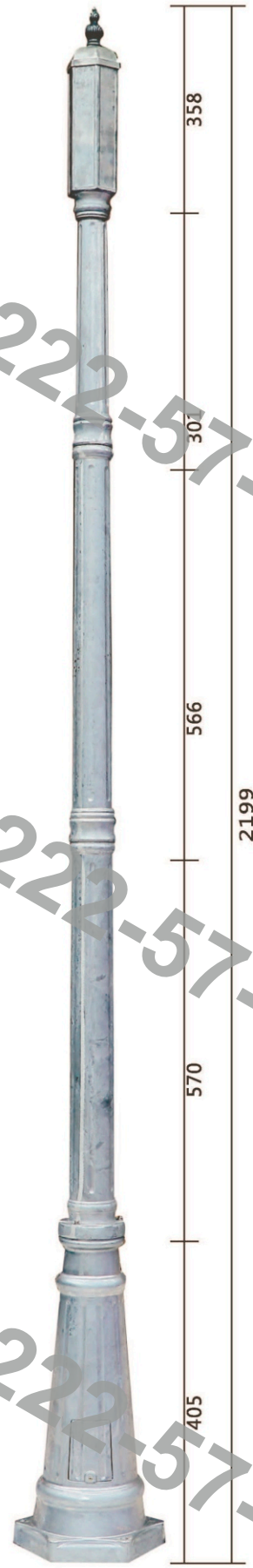

CR5002-3



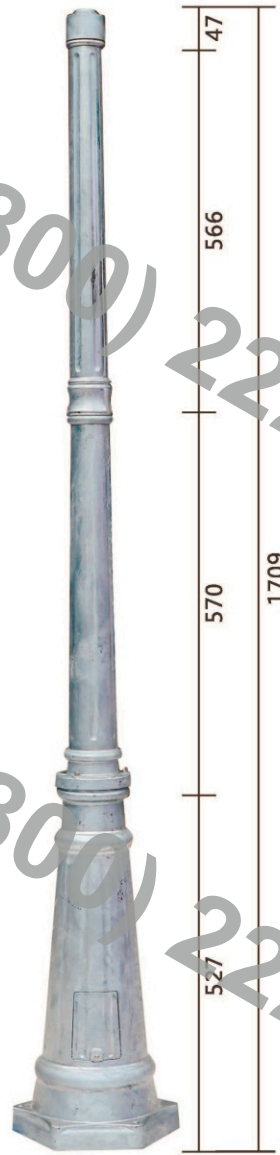
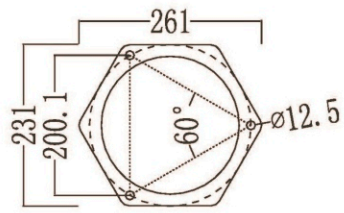

CR5003-1

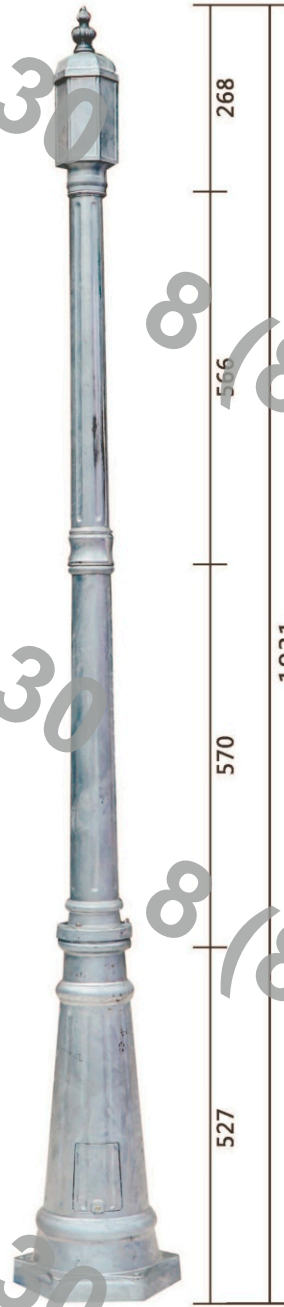

CR5003-2

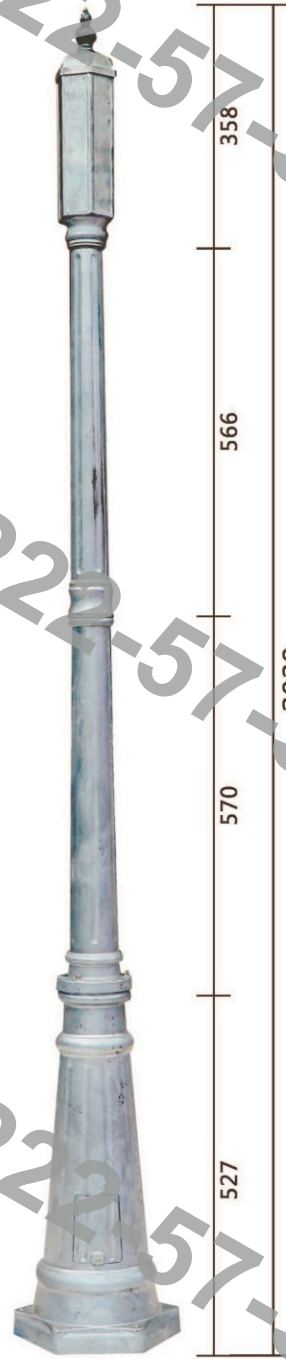

CR5003-3



CR5004-1

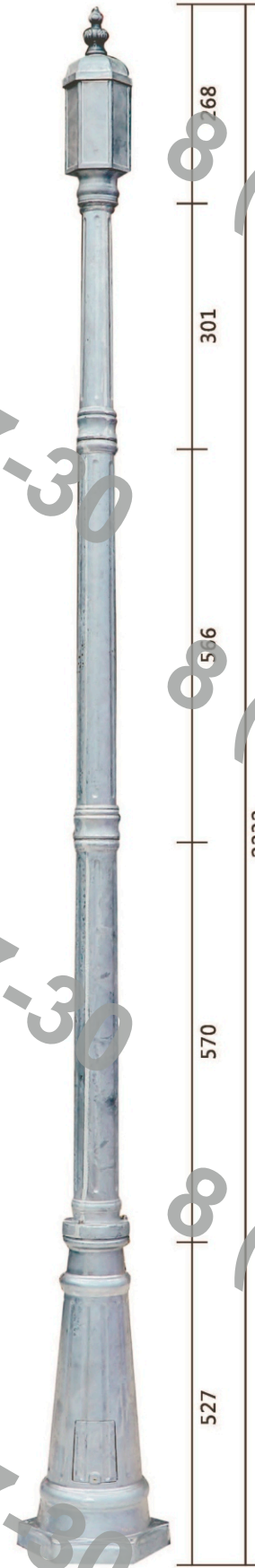

CR5004-2

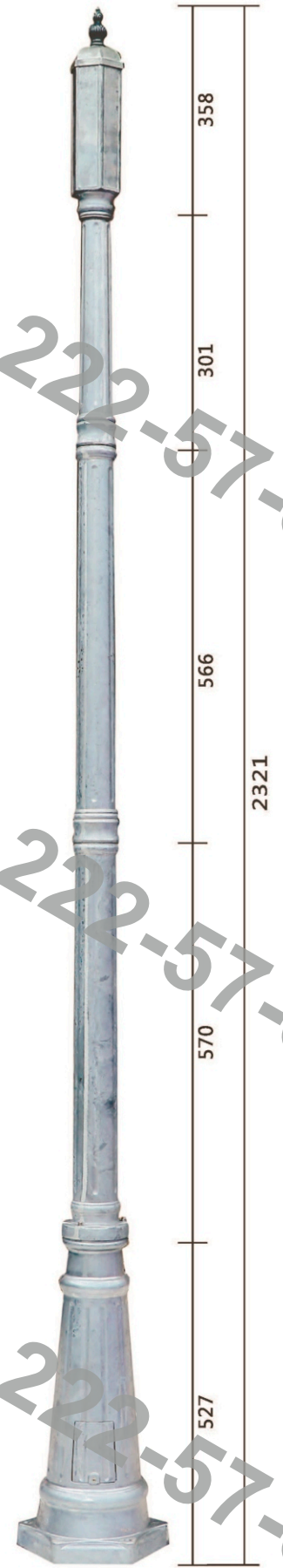

CR5004-3

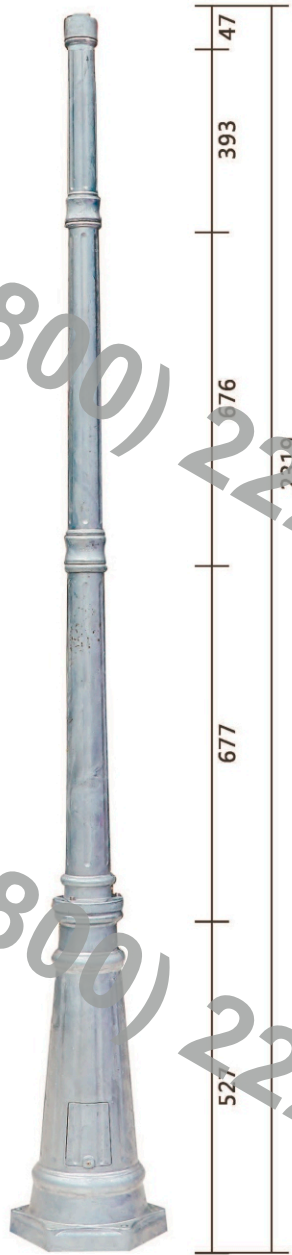

CR5005-1

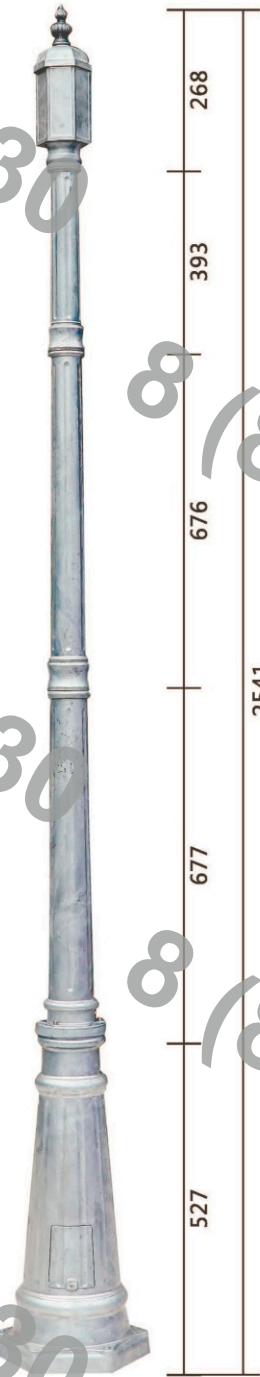

CR5005-2

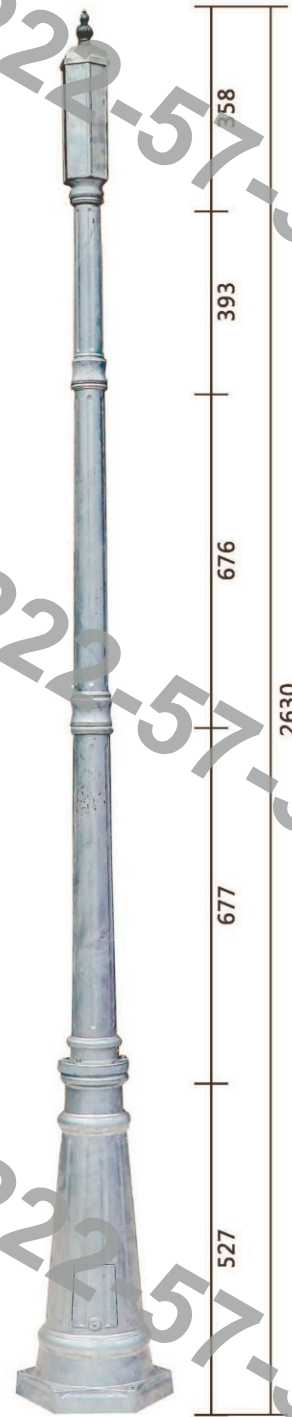

CR5005-3

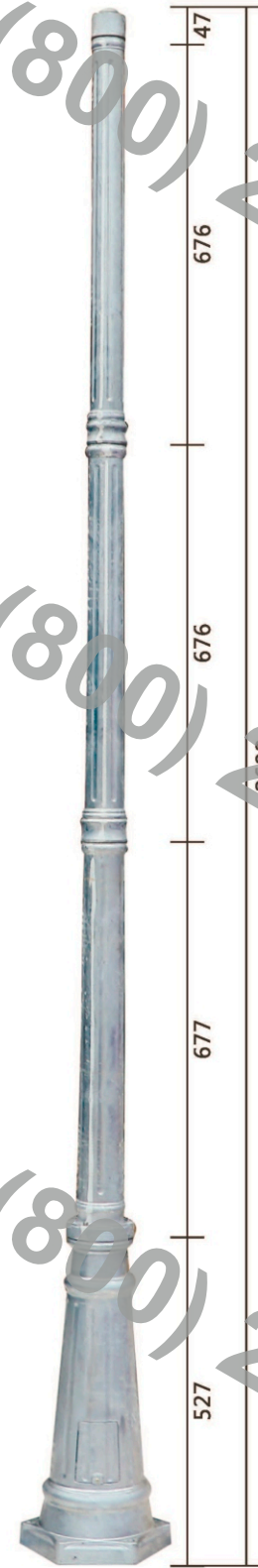

CR5006-1



CR5006-2

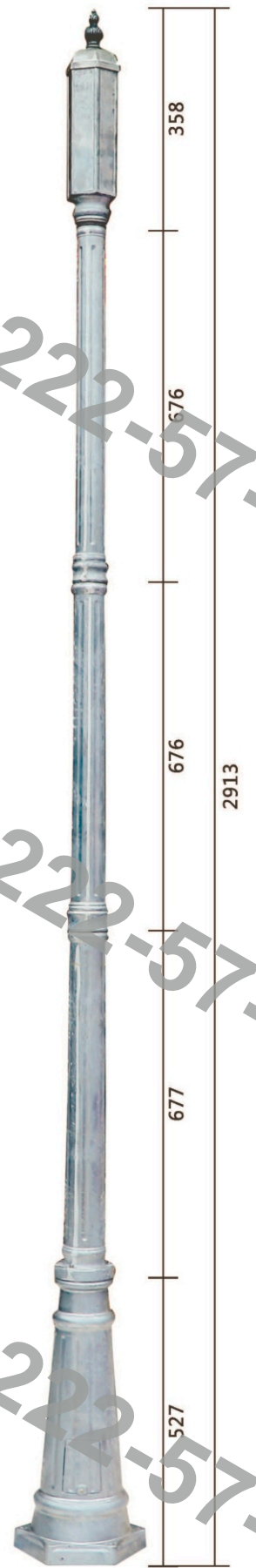

CR5006-3



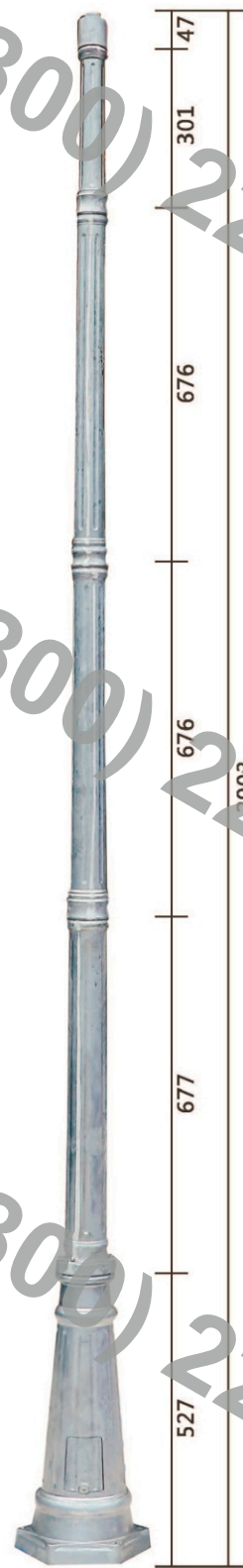

CR5007-1



CR5007-2



CR5007-3

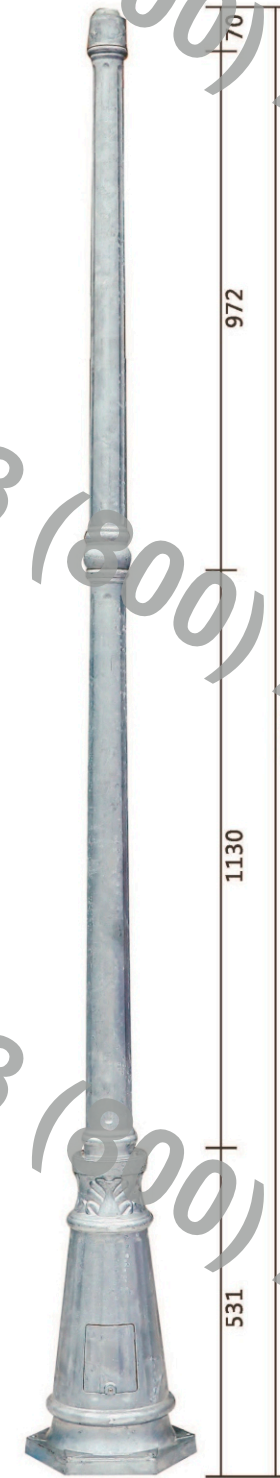

CR5008-1

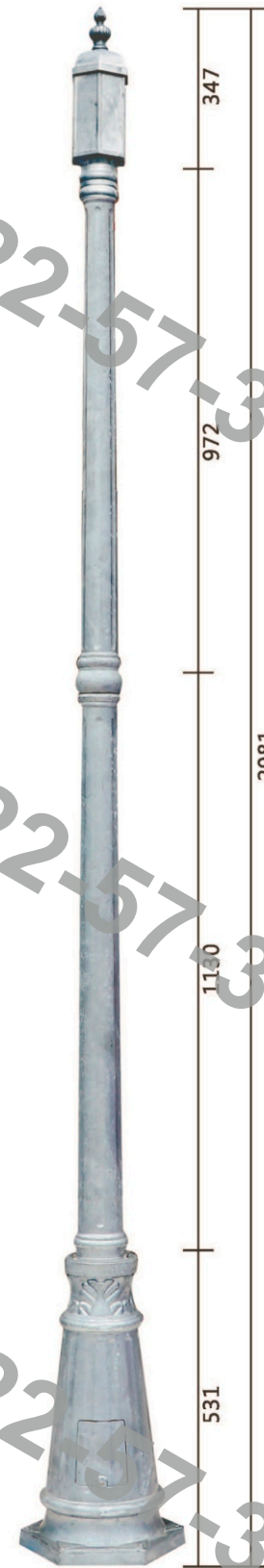
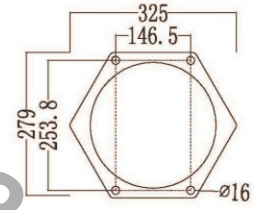

CR5008-2



CR5008-3

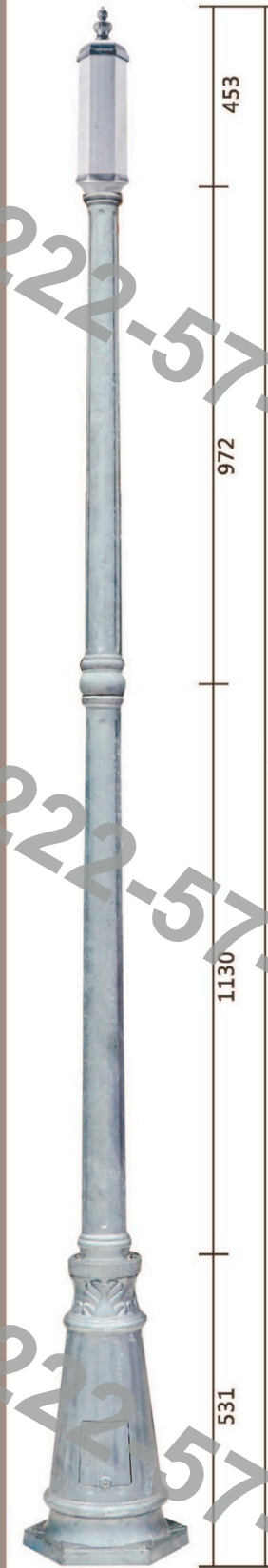

CR5008-4

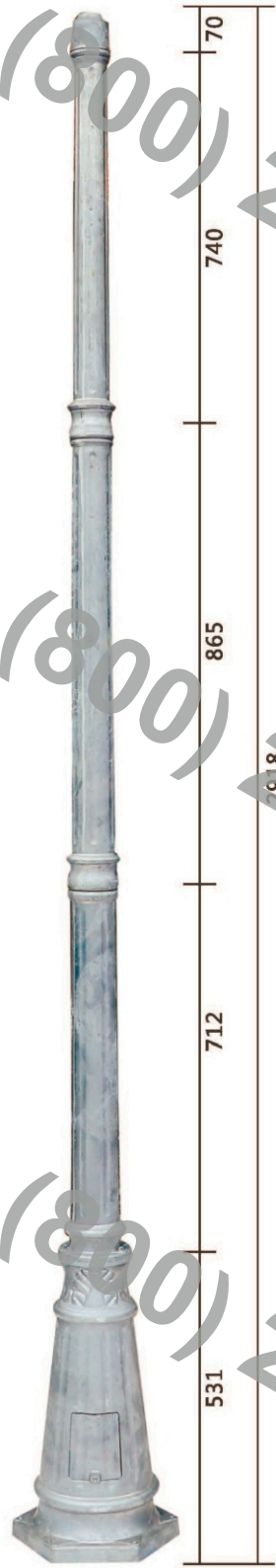

CR5009-1

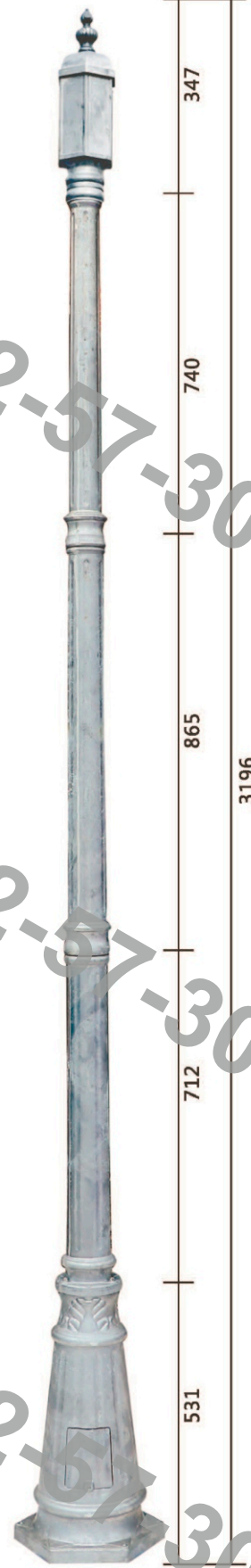

CR5009-2

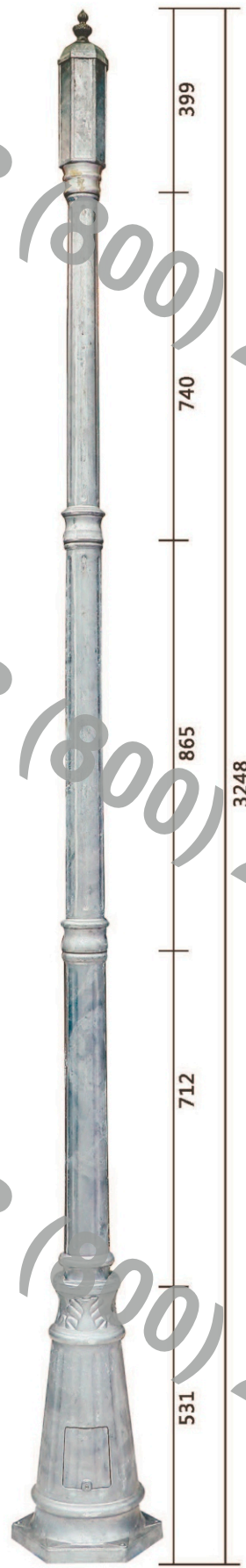

CR5009-3

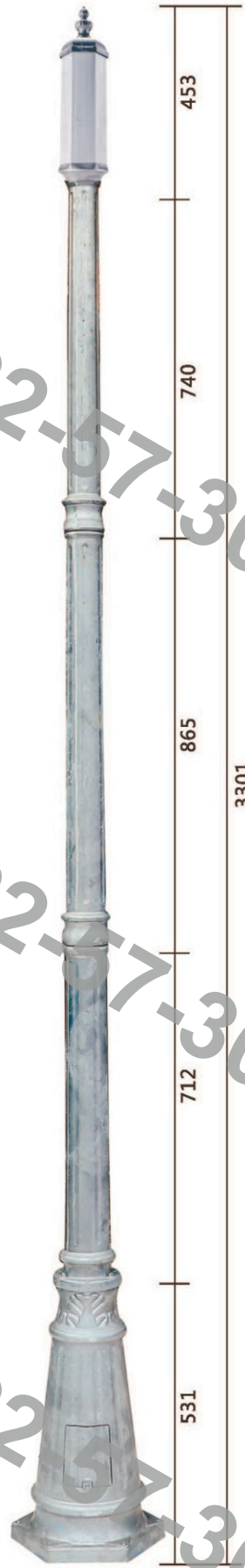

CR5009-4

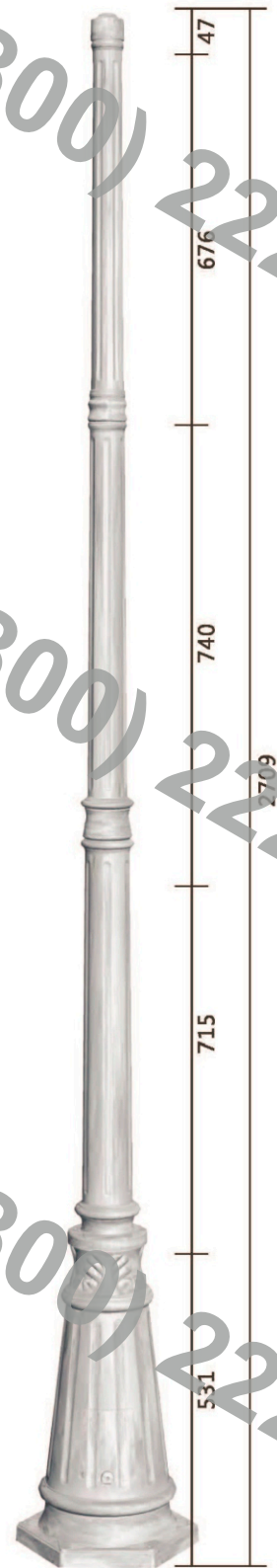

CR5010-1

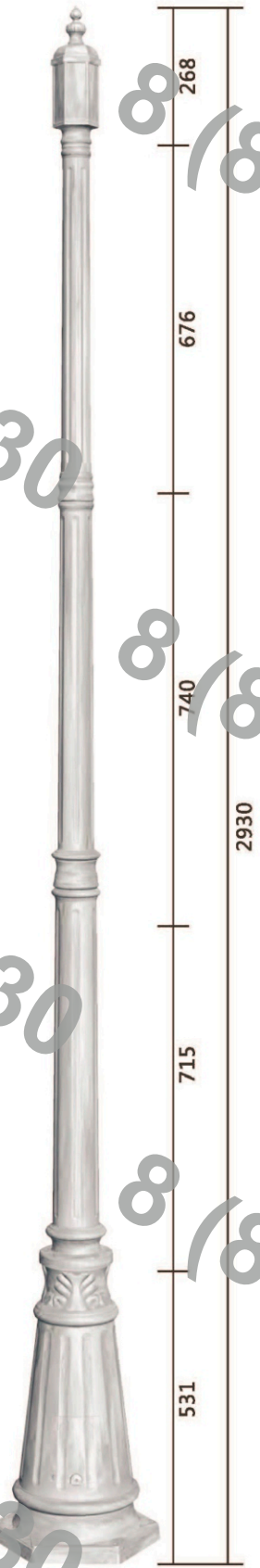

CR5010-2



CR5010-3



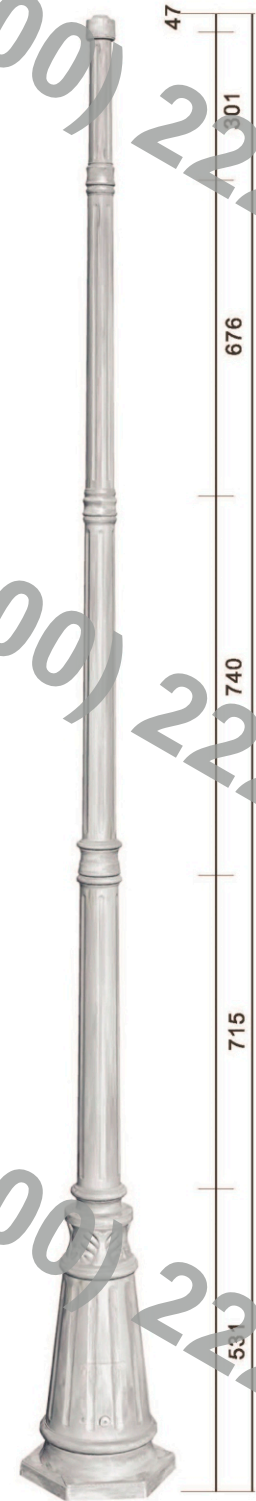

CR5011-1



CR5011-2



CR5011-3



CR5012



CR5013

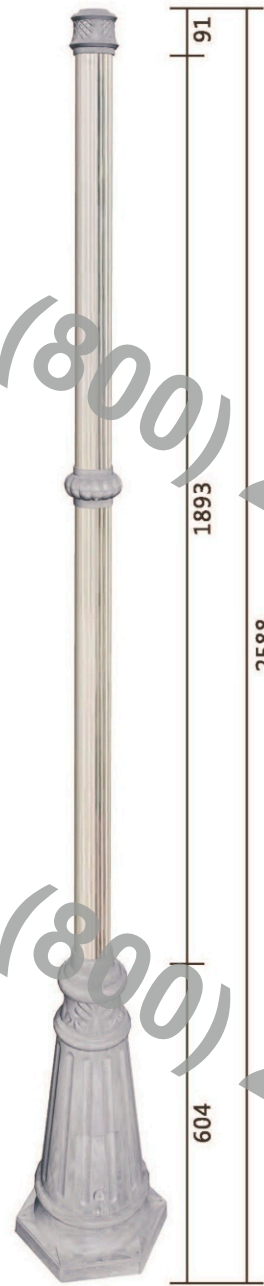

CR5014-1

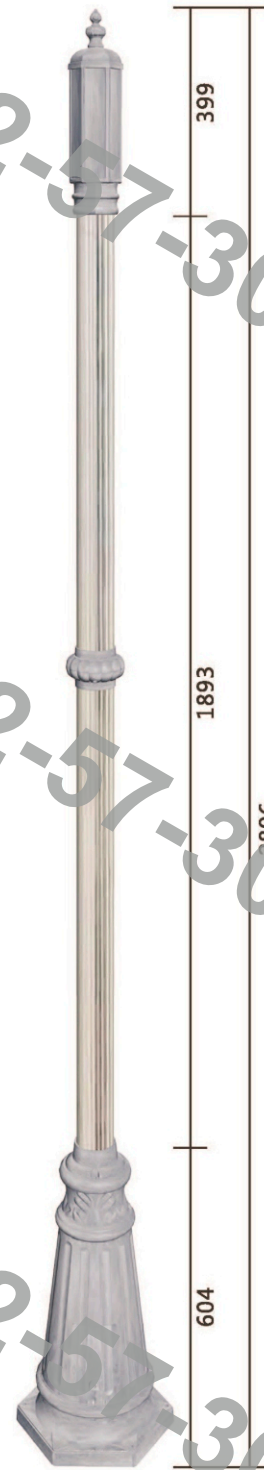

CR5014-2

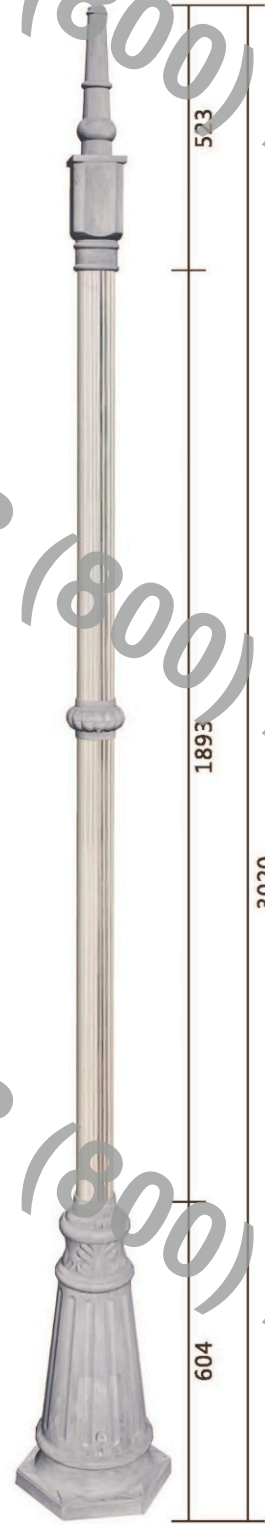

CR5014-3

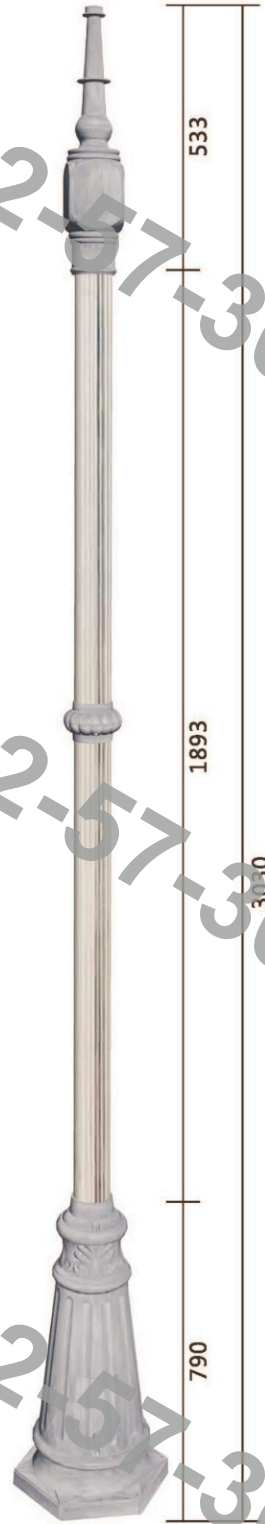

CR5014-4

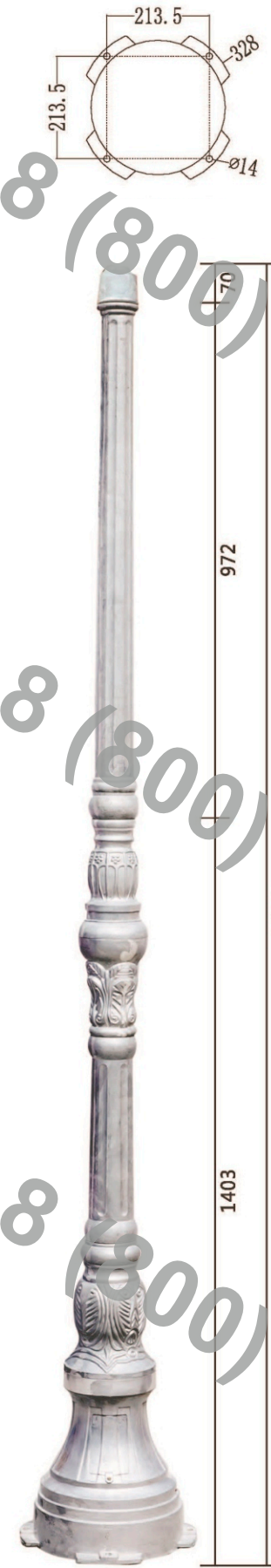

CR5015-1

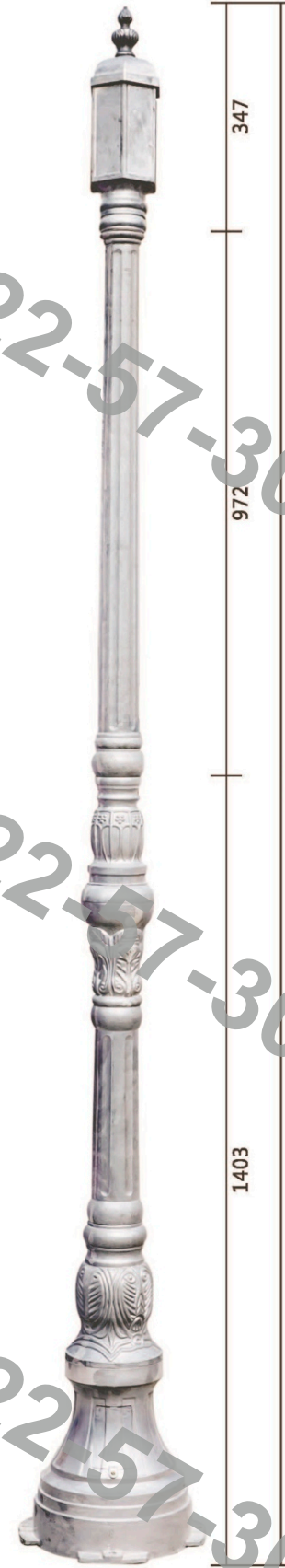

CR5015-2



CR5015-3

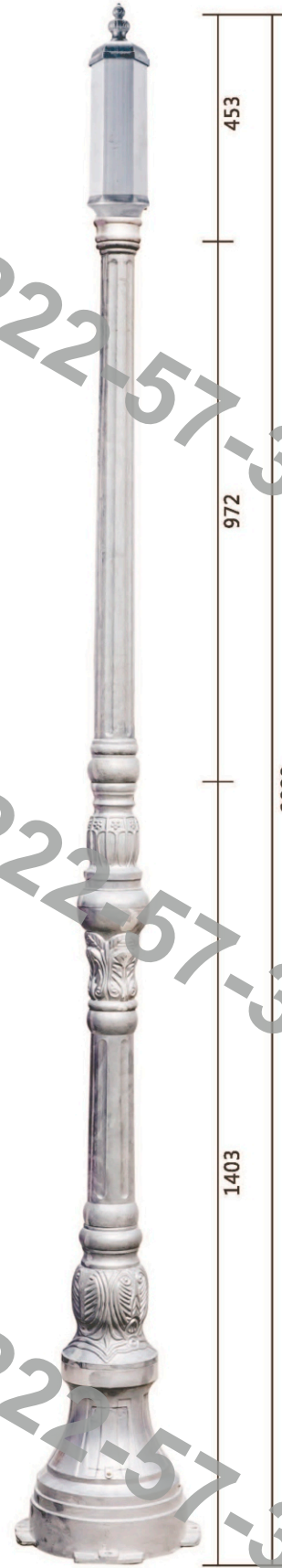

CR5015-4





CR1016-1



CR1016-2

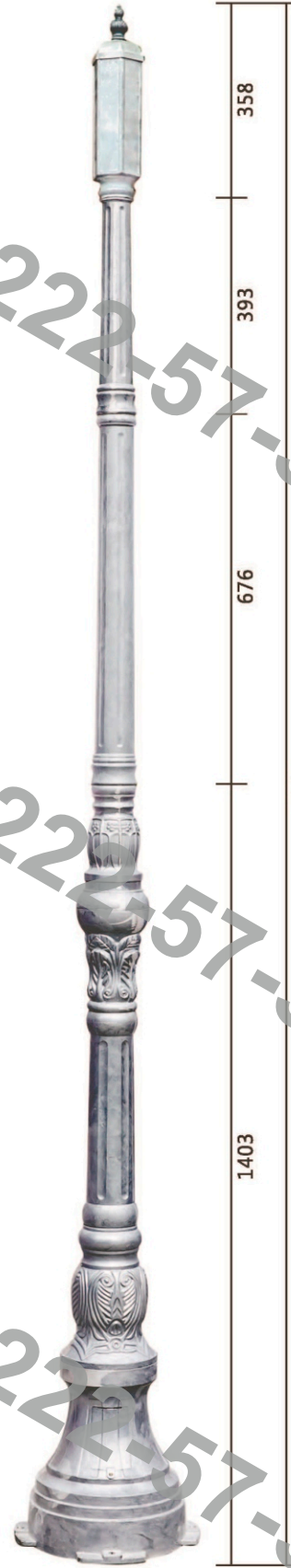

CR1016-3

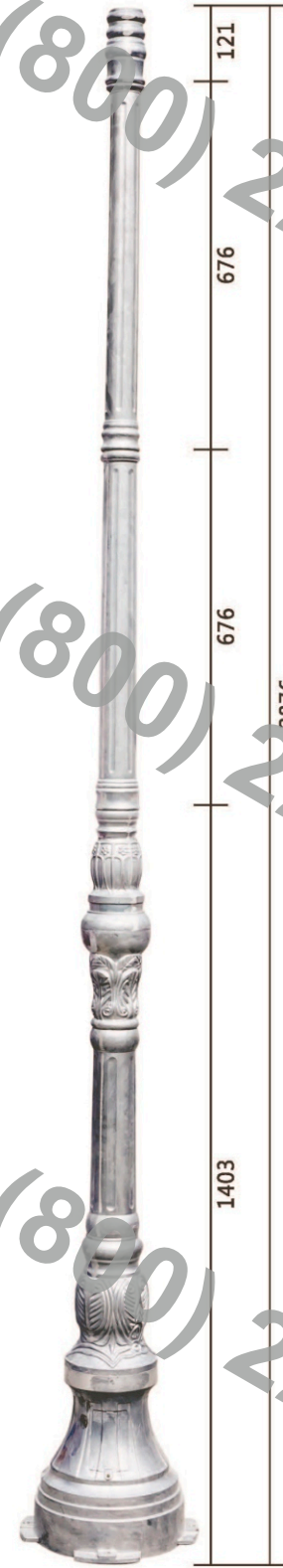

CR1017-1

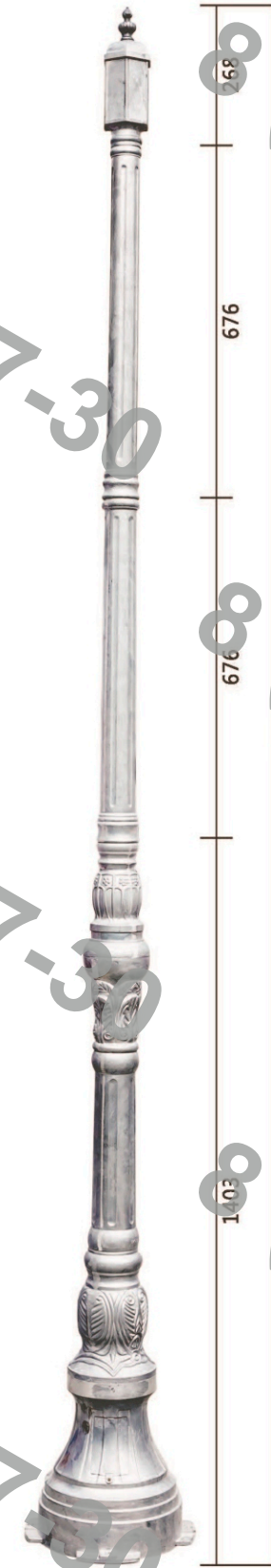

CR1017-2



CR1017-3

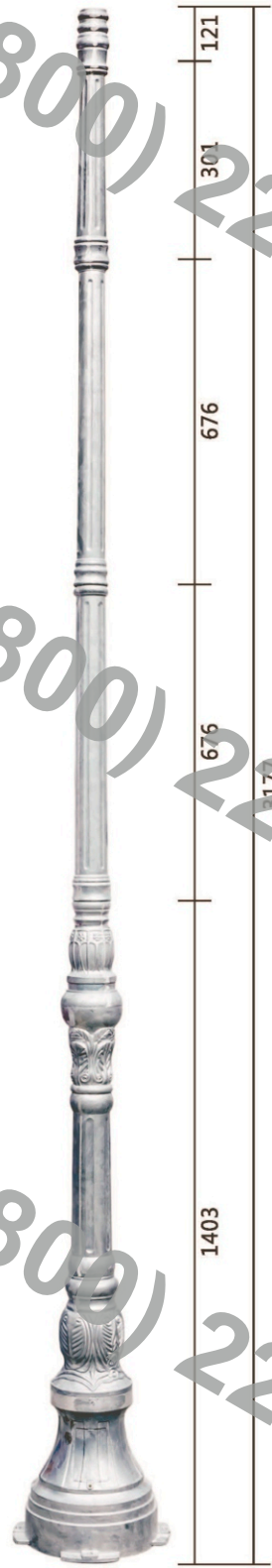

CR5018-1

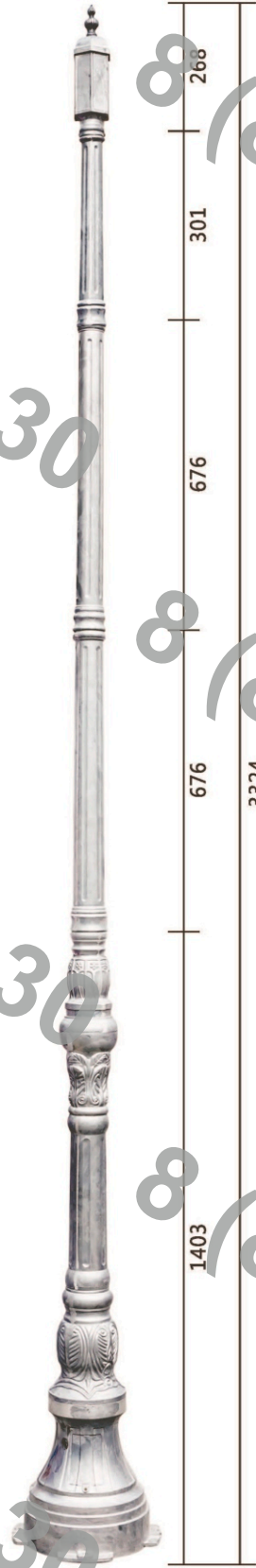

CR5018-2



CR5018-3



CR5019-1

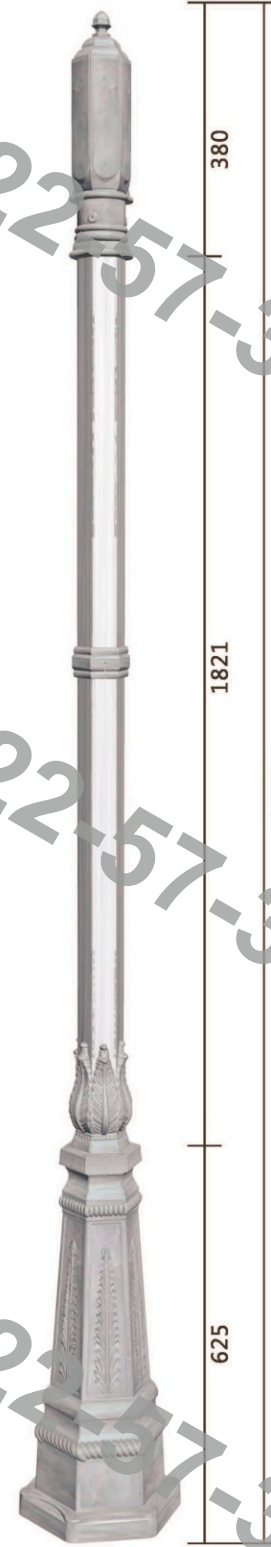

CR5019-2

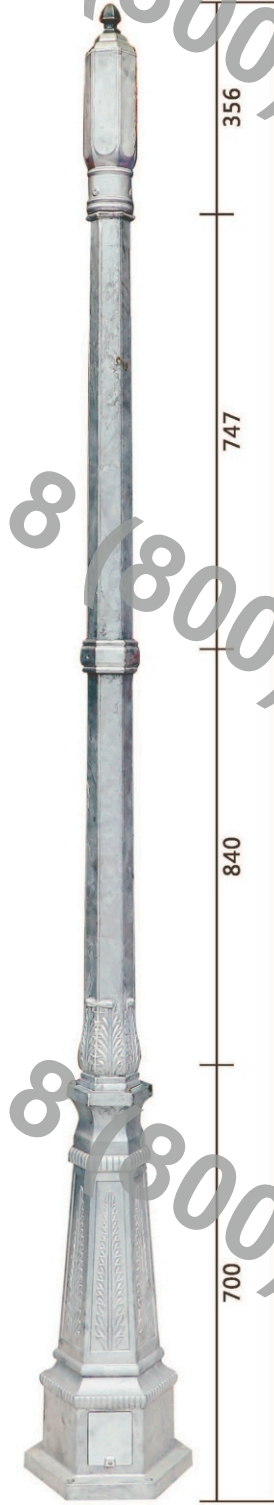

CR5020-1



CR5020-2

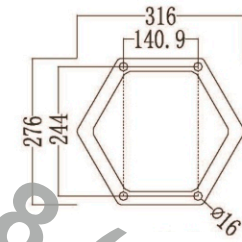
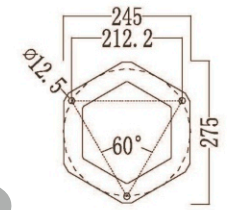



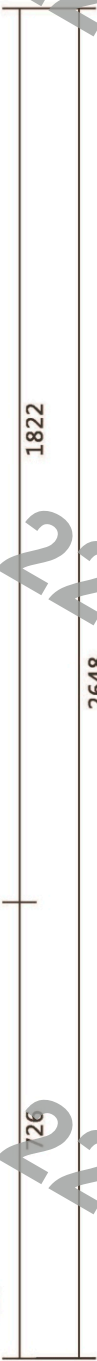
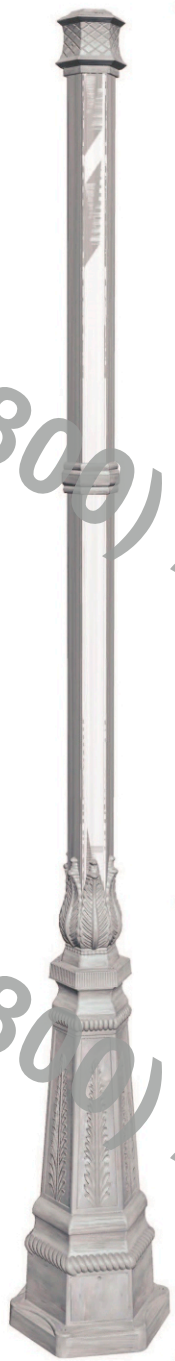

CR5021-1



CR5021-2



CR5021-3

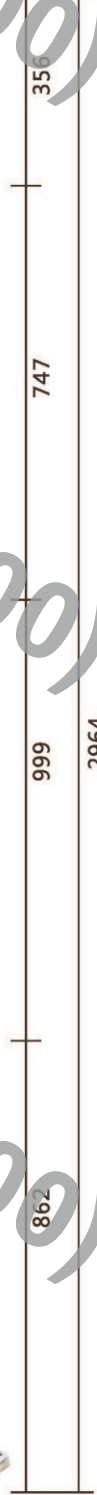

CR5022-1



CR5022-2



CR5023-1



CR5023-2

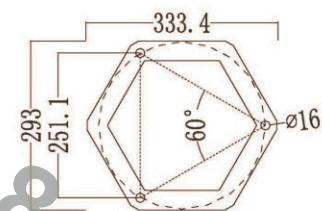

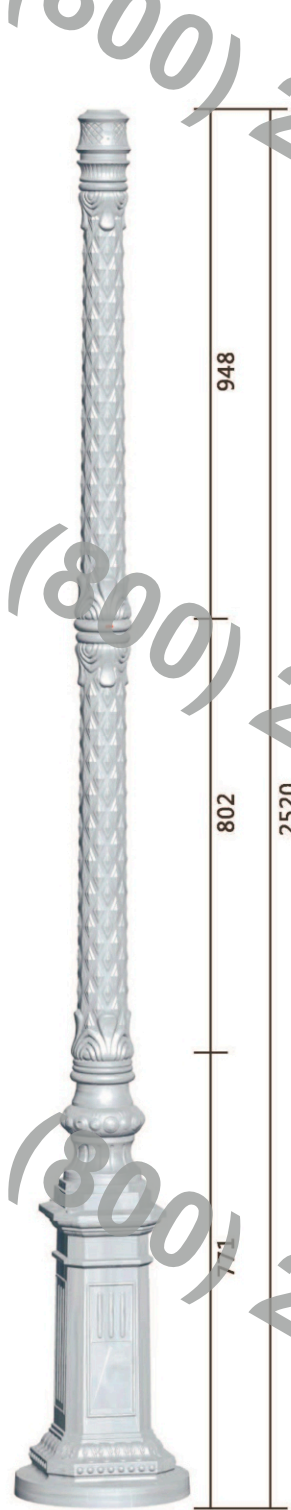
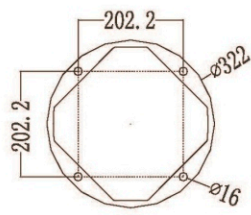

CR5024-1

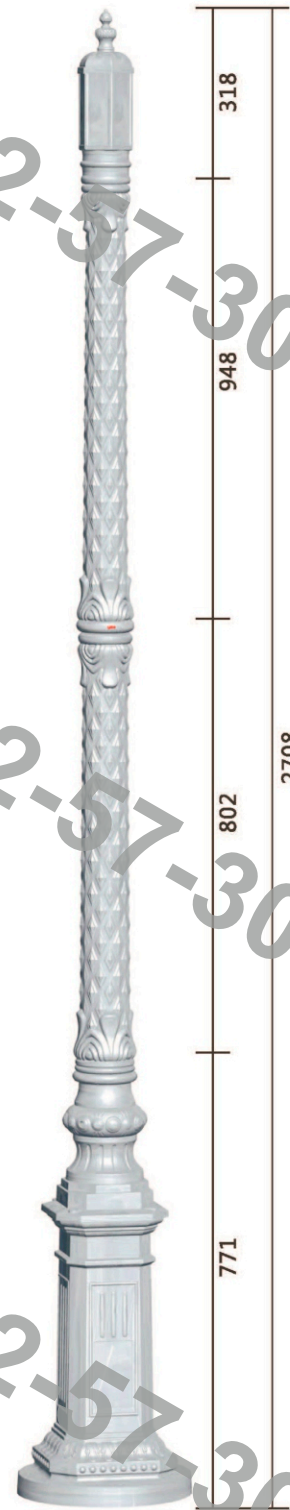

CR5024-2



CR5024-3



CR5024-4



CR5024-5



CR5024-6



CR5024-7



CR5024-8



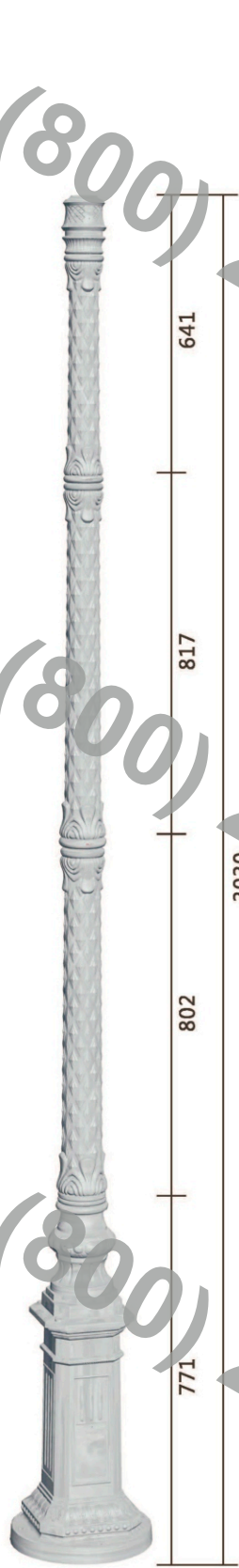

CR5025-1

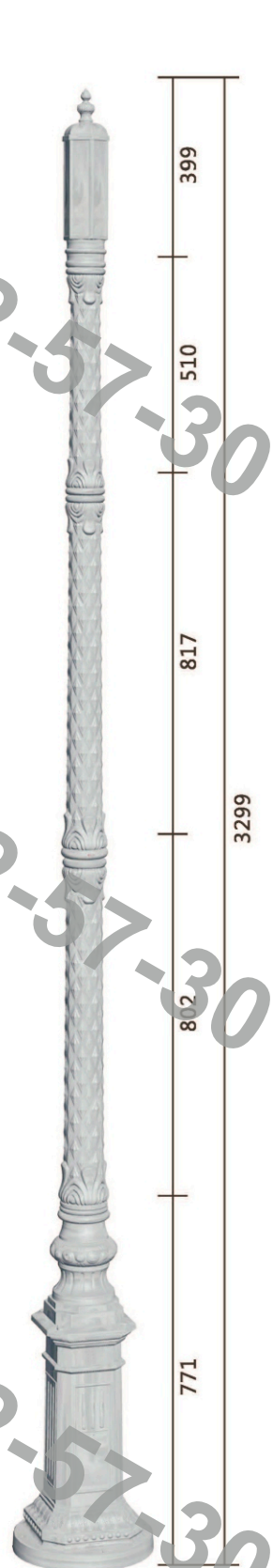

CR5025-2



CR5025-3

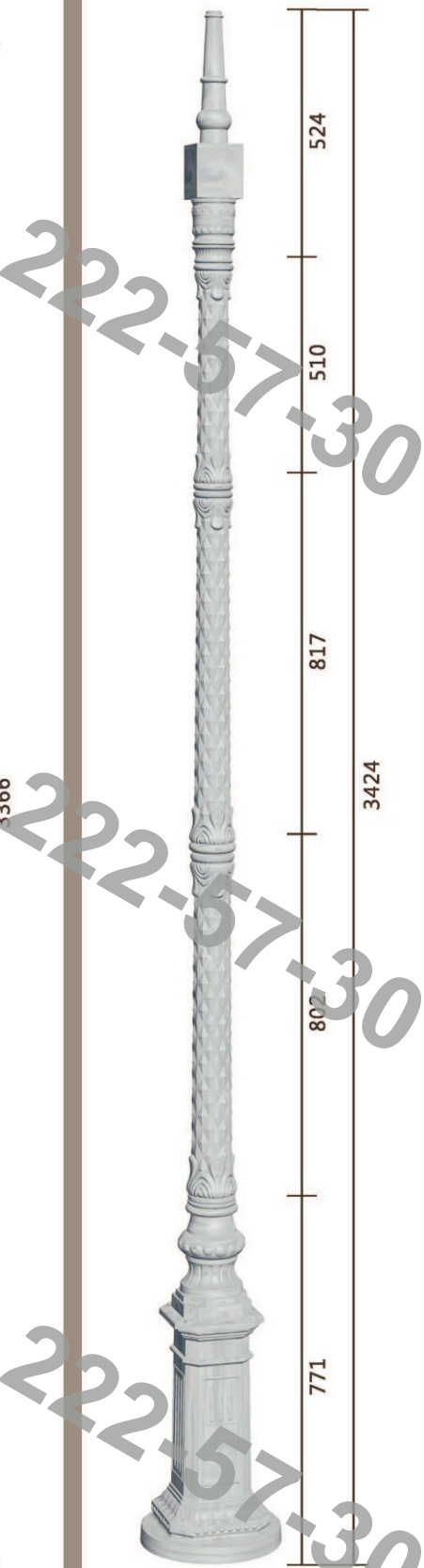

CR5025-4



CR5026-1

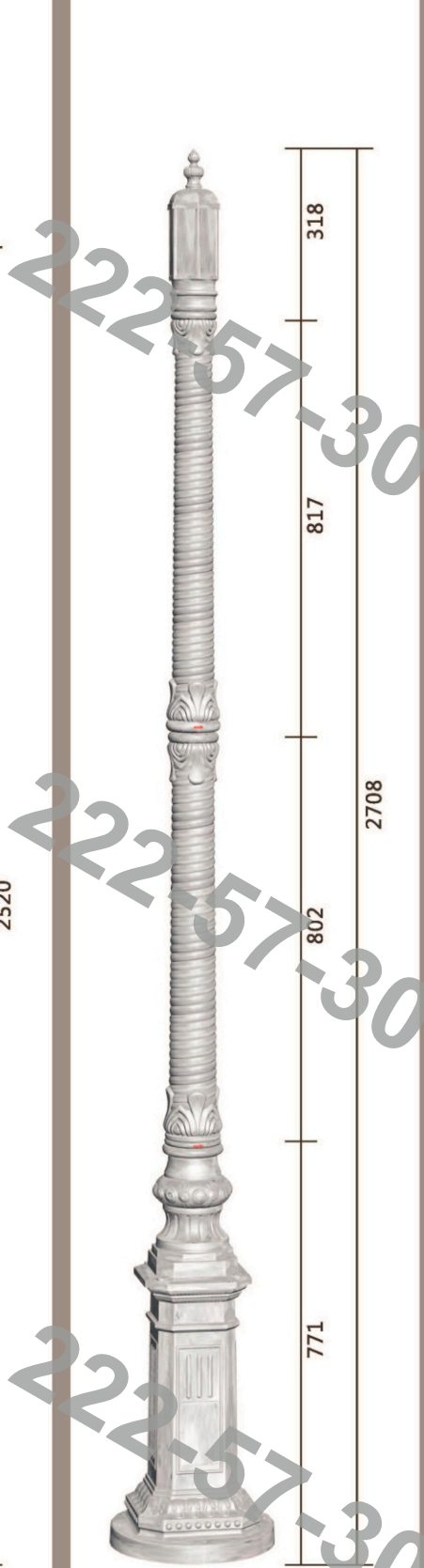

CR5026-2



CR5026-3

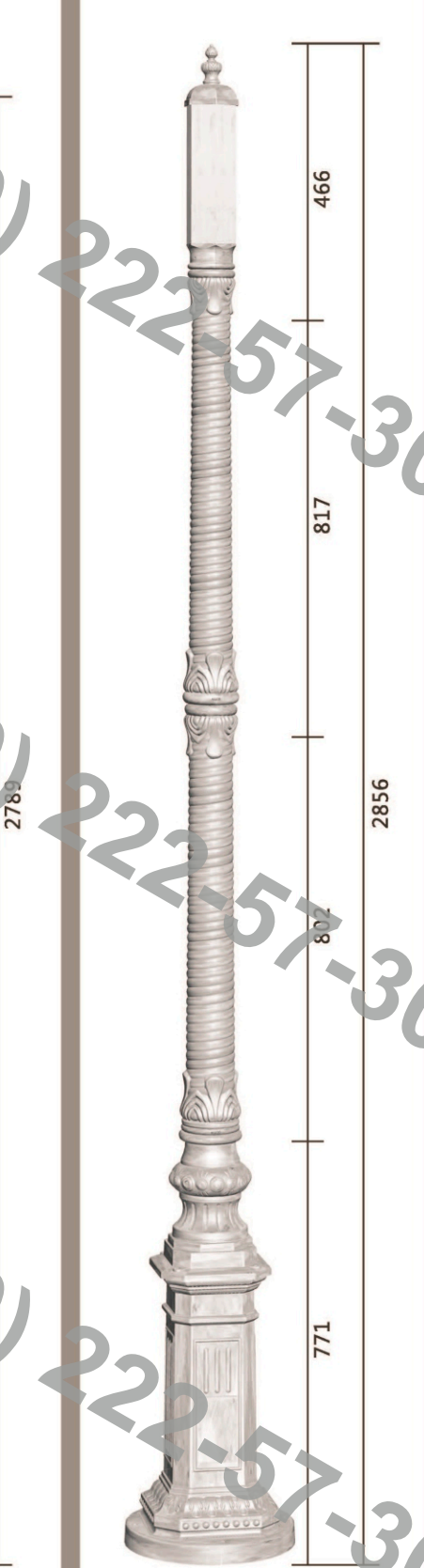

CR5026-4





CR5026-5



CR5026-6



CR5026-7

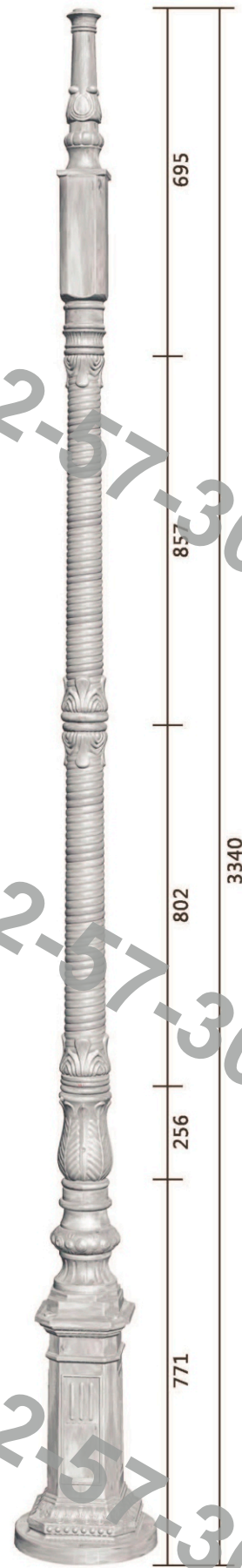

CR5026-8



CR5027-1



CR5027-2

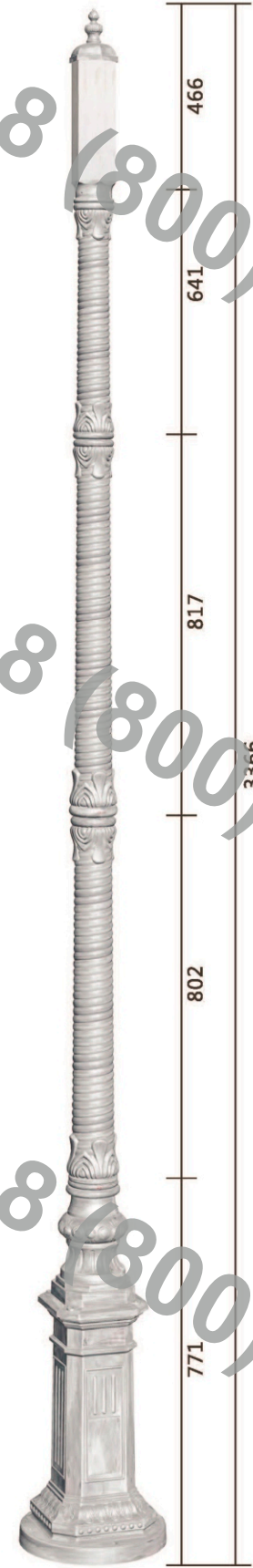

CR5027-3

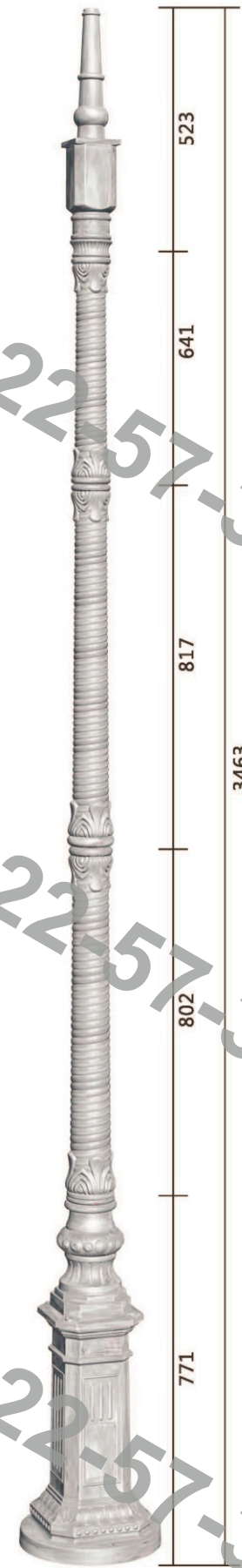

CR5027-4



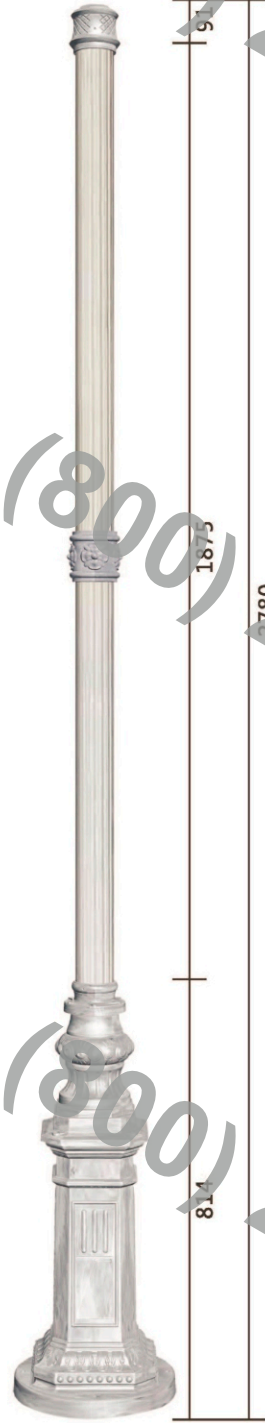

CR5028-1

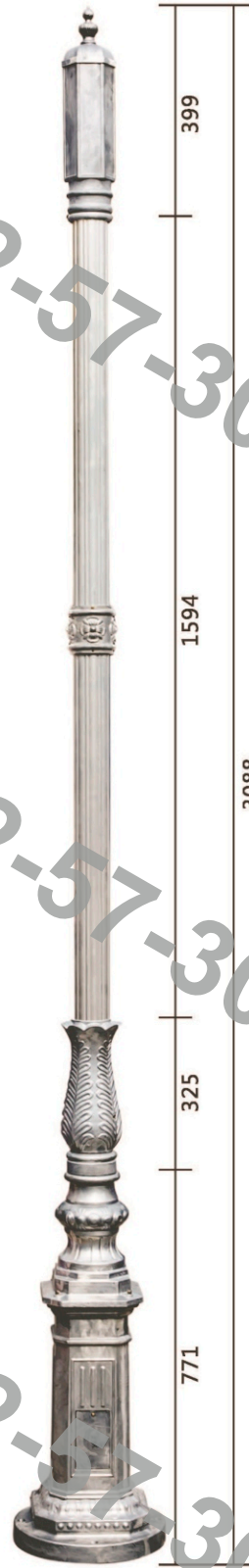

CR5028-2



CR5028-3



CR5028-4

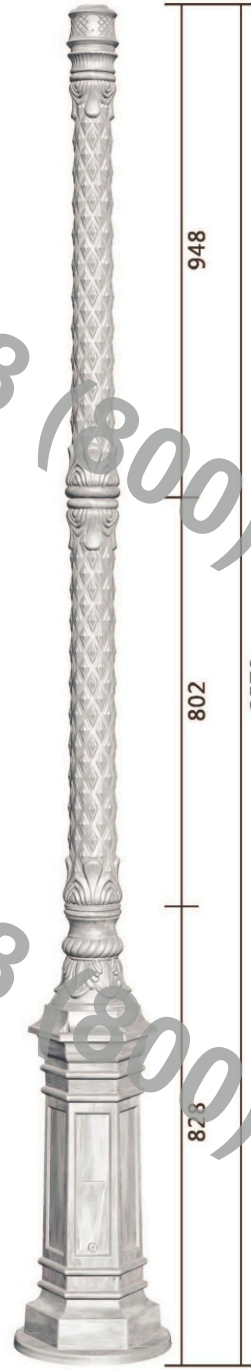

CR5029-1

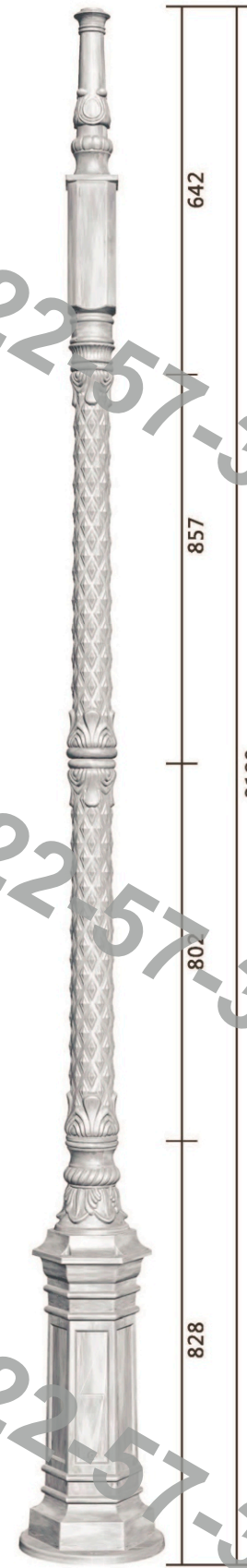
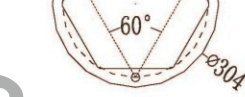

CR5029-2



CR5029-3



CR5030





CR5031-1



CR5031-2



CR5031-3

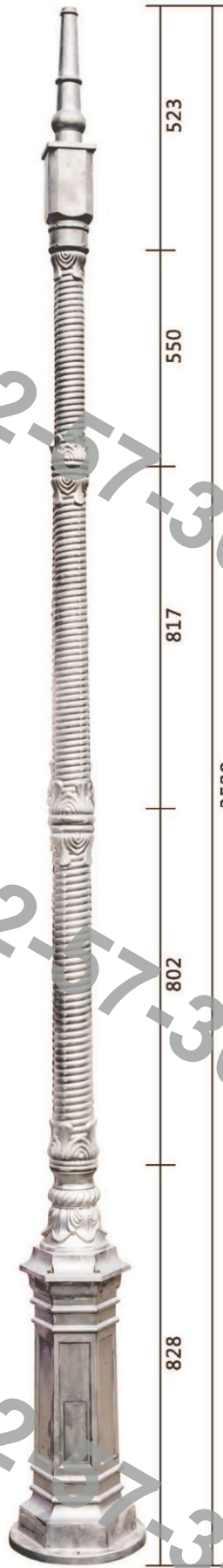

CR5032



CR5033-1



CR5033-2



CR5033-3

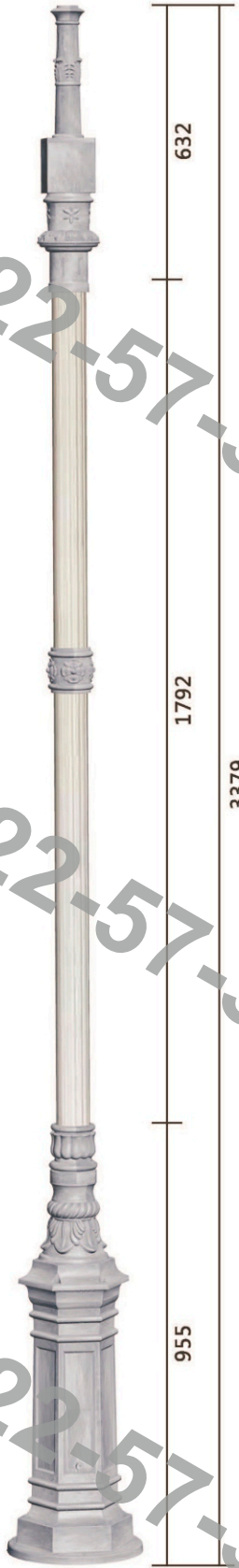

CR5033-4



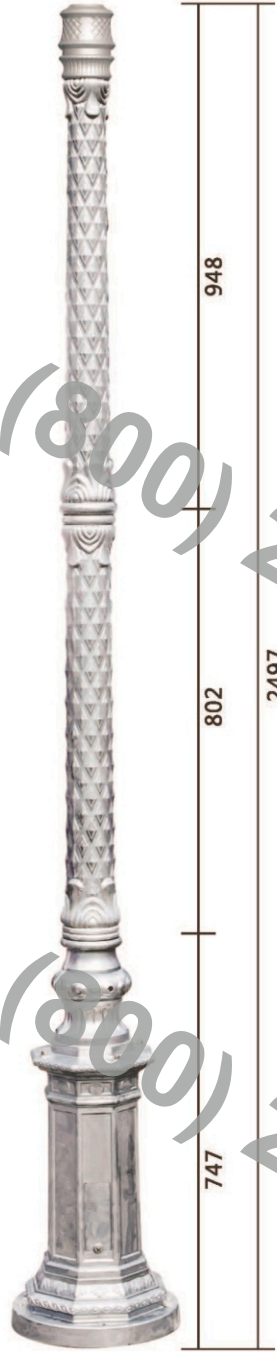
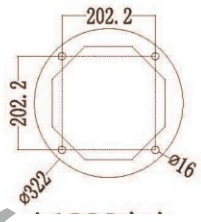

CR5034-1

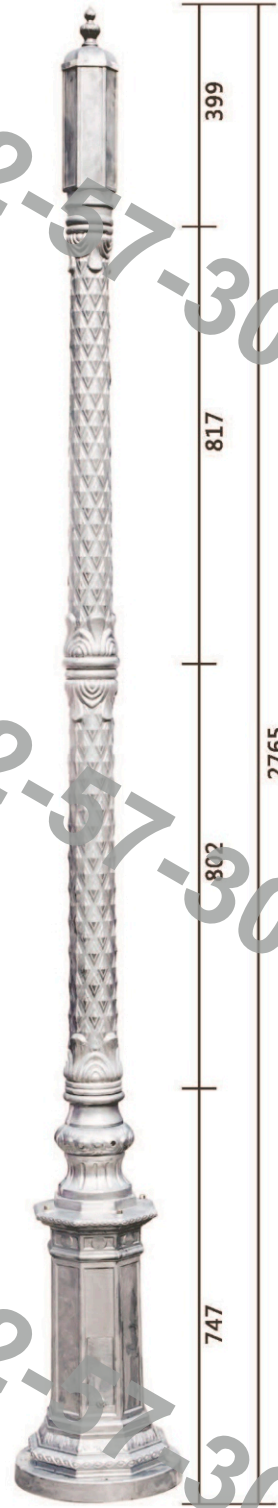

CR5034-2

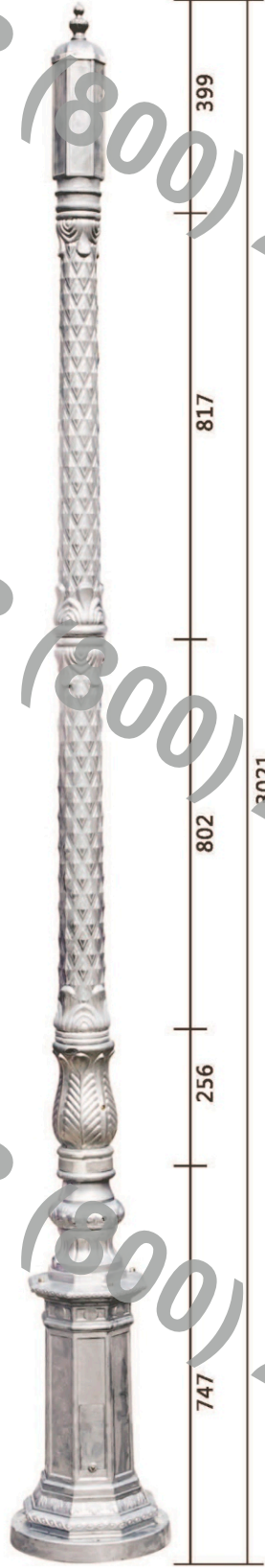

CR5034-3

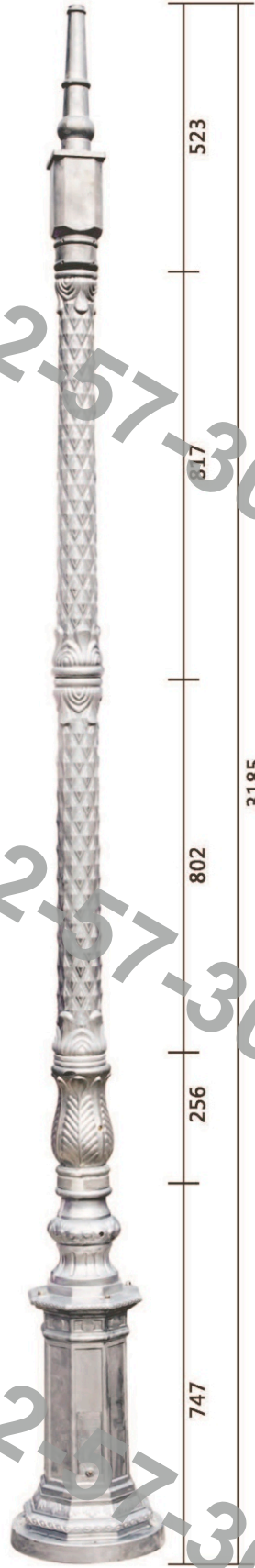

CR5034-4



CR5035-1



CR5035-2



CR5035-3



CR5035-4





CR5036-1

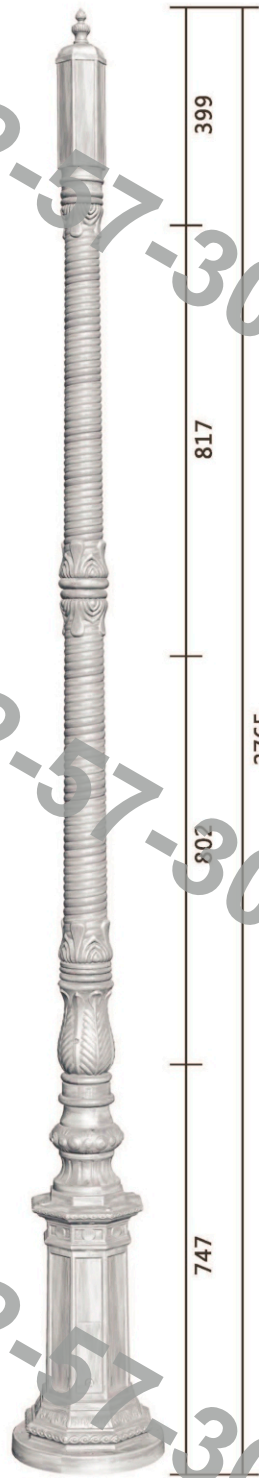

CR5036-2



CR5036-3

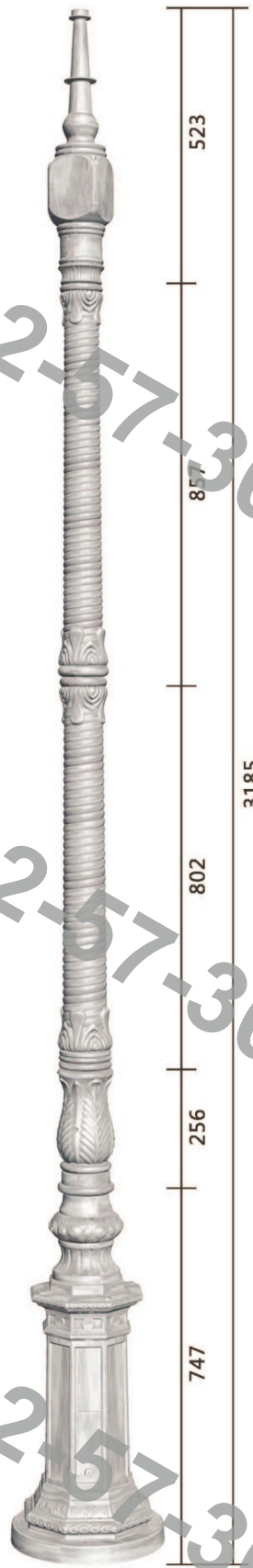

CR5036-4

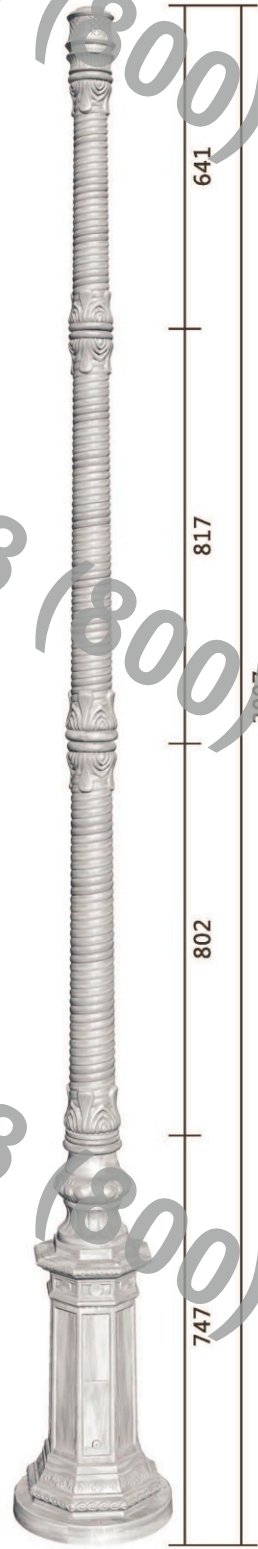

CR5037-1

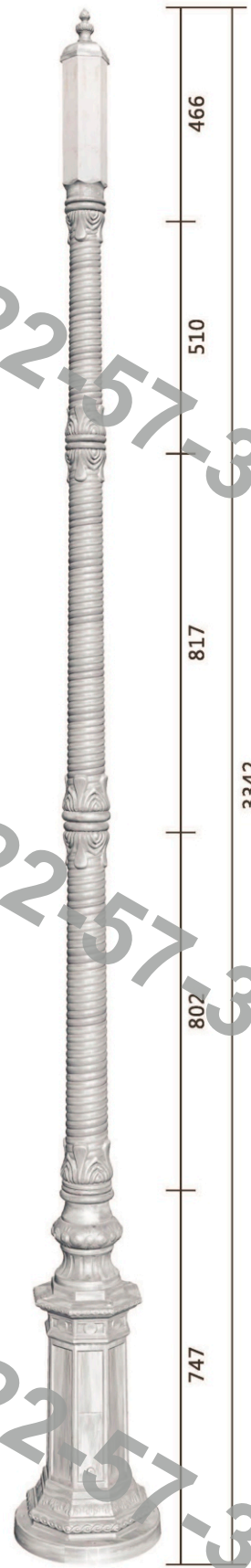

CR5037-2



CR5037-3



CR5037-4





CR5038-1



CR5038-2



CR5038-3



CR5038-4



CR5039-1

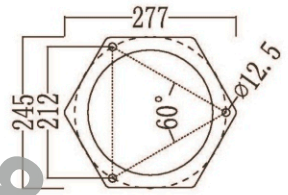

CR5039-2



CR5040-1

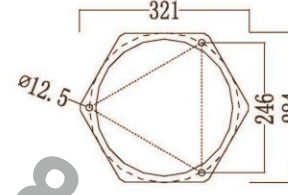

CR5040-2



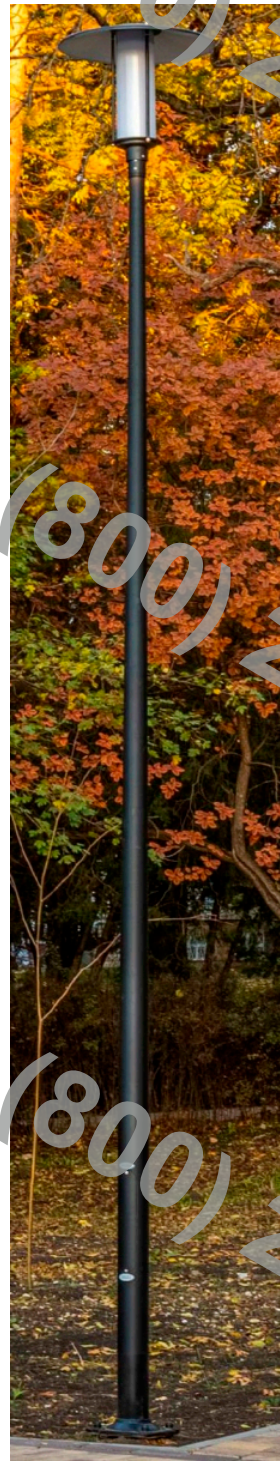

CR-C-AL120



CR-C-AL160

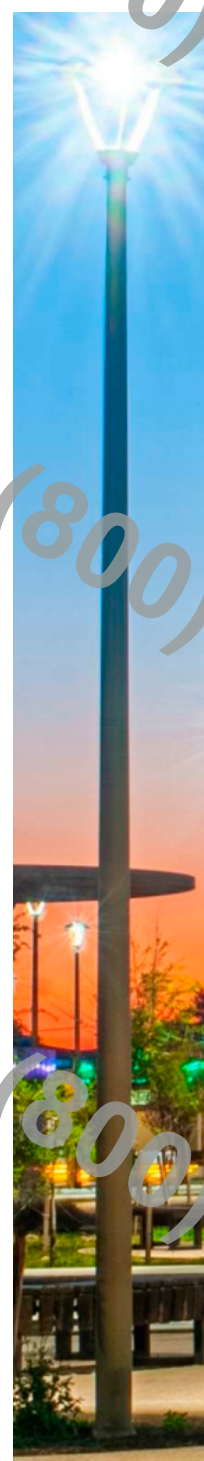

CR-C-AL180

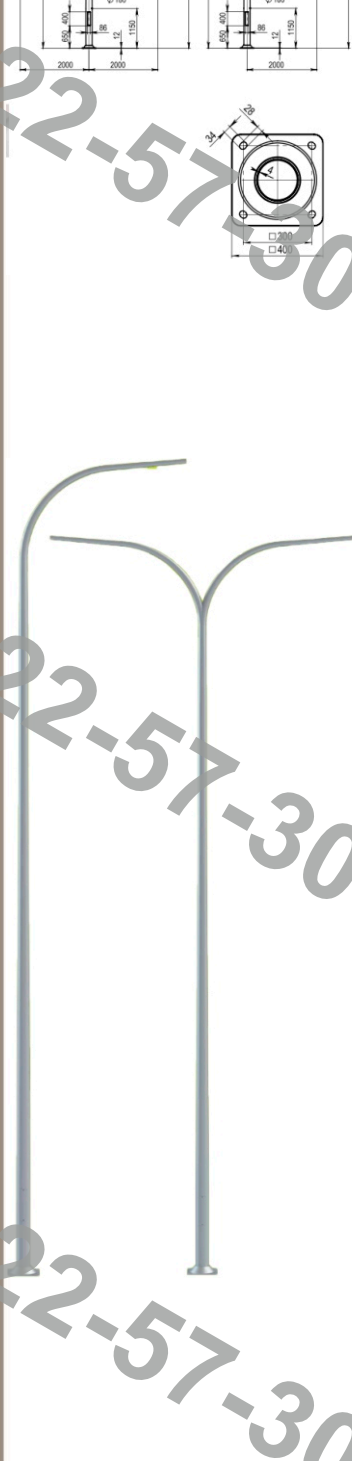

CR-H-AL180



CR-B-AL160



CR-B-AL-B1160

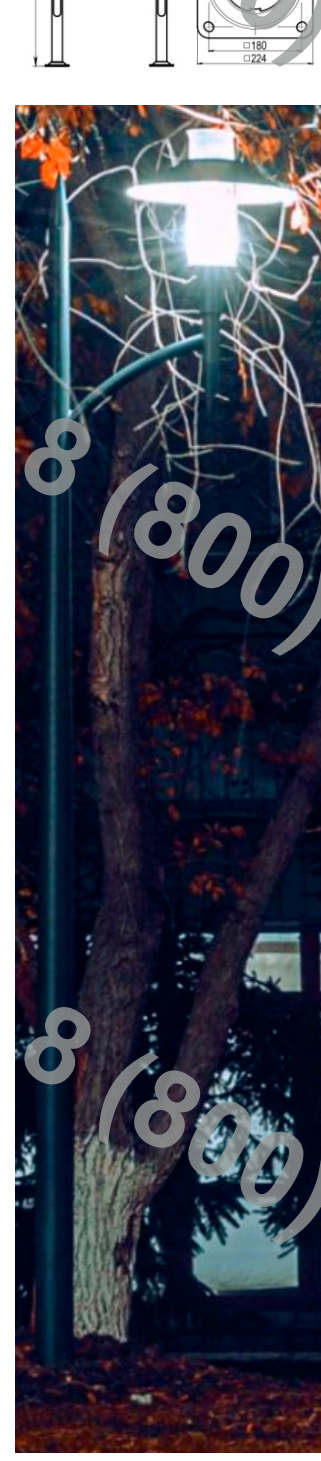

CR-M-AL-B1/2



CR-M-AL-M1/2

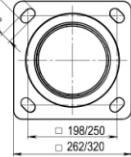
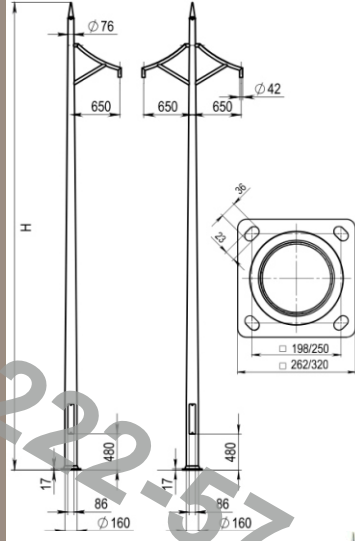
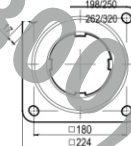
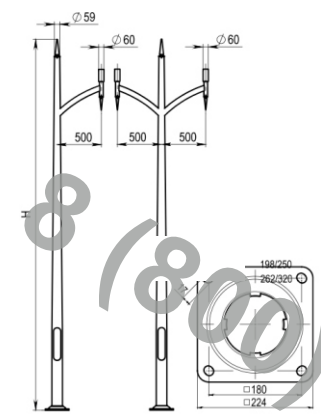
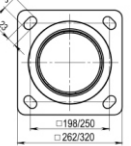
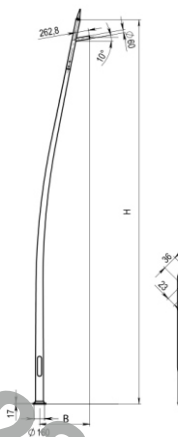
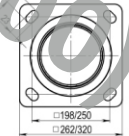
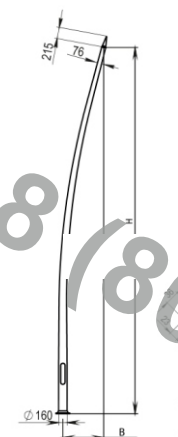
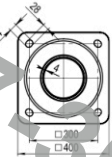
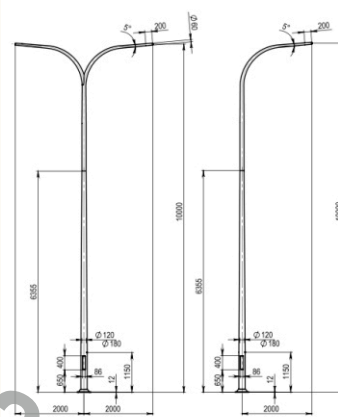
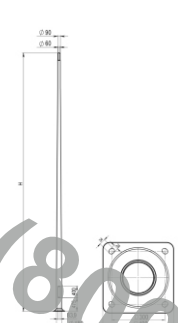
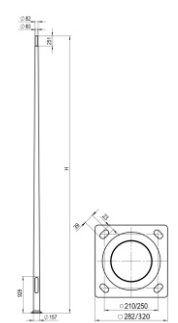
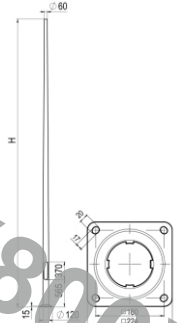



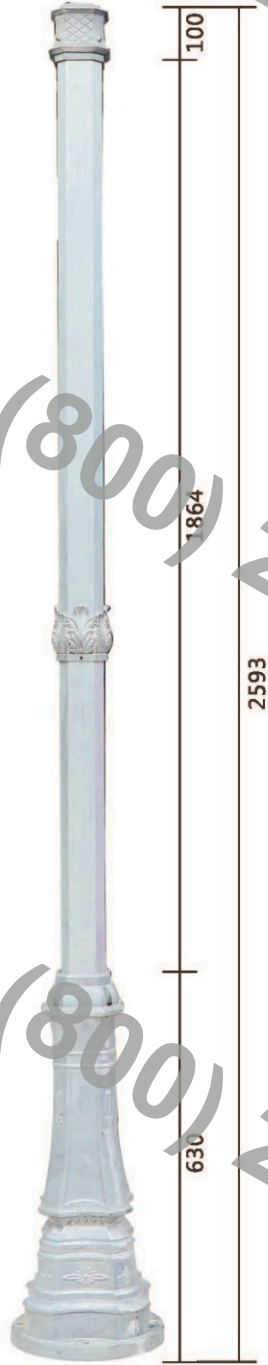
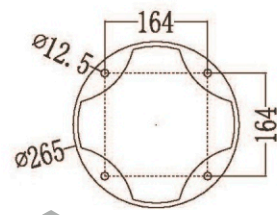

Cr5041

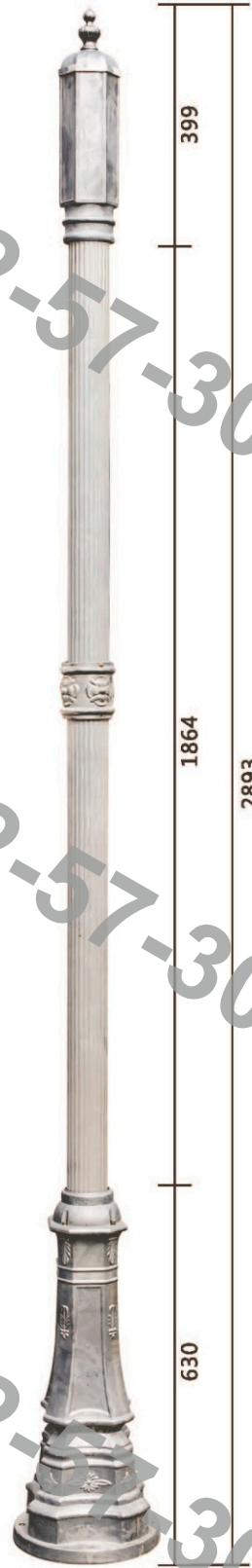

CR5042-1



CR5042-2



CR5042-3

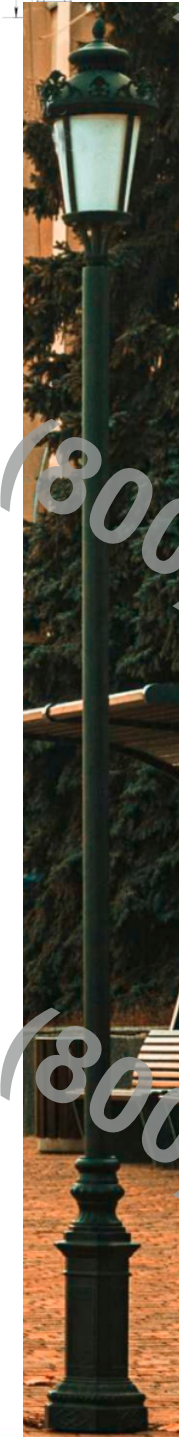

CR-P-AL-L

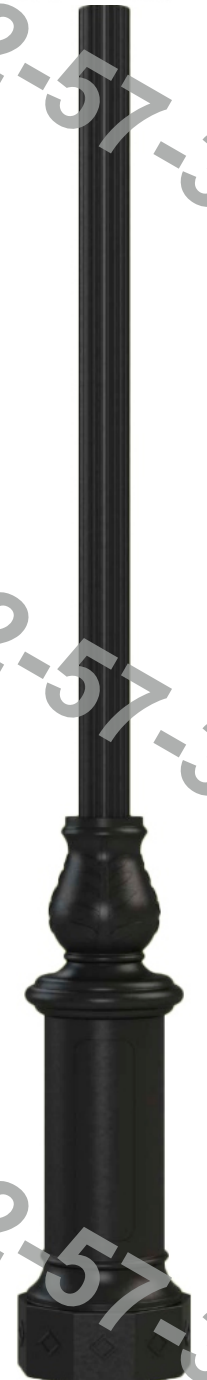
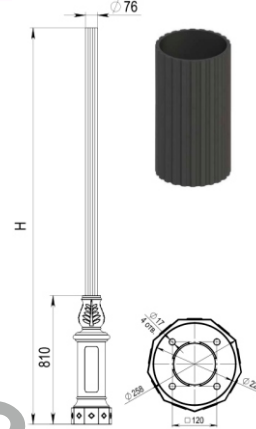

CR-P-AL-Pr

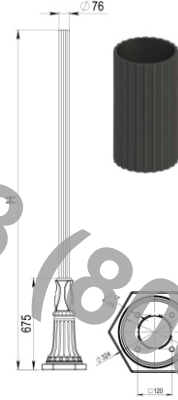

CR-P-AL-R

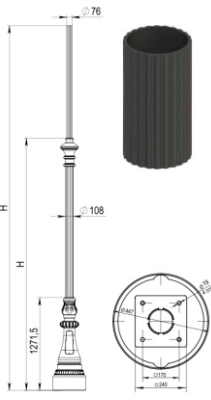

CR-P-AL-P